

Measurement of Fluid Film Thickness on the Valve Plate in Oil Hydraulic Axial Piston Pumps (I)

— Bearing Pad Effects —

Jong-Ki Kim

*Graduate School of Precision Mechanical Engineering, Chonbuk National University,
Chonbuk 561-756, Korea*

Jae-Youn Jung*

*School of Mechanical and Aerospace System Engineering, Chonbuk National University,
Chonbuk 561-756, Korea*

The tribological mechanism between the valve plate and the cylinder block in oil hydraulic axial piston pumps plays an important role on high power density. In this study, the fluid film thickness between the valve plate and the cylinder block was measured with discharge pressure and rotational speed by use of a gap sensor, and a slip ring system in the operating period. To investigate the effect of the valve plate shapes, we designed two valve plates with different shapes: the first valve plate was without a bearing pad, while the second valve plate had a bearing pad. It was found that both valve plates behaved differently with respect to the fluid film thickness characteristics. The leakage flow rates and the shaft torque were also experimented in order to clarify the performance difference between the valve plate without a bearing pad and the valve plate with a bearing pad. From the results of this study, we found out that in the oil hydraulic axial piston pumps, the valve plate with a bearing pad showed better film thickness contours than the valve plate without a bearing pad.

Key Words : Oil Hydraulic Axial Piston Pump, Fluid Film Thickness, Valve Plate

Nomenclature

D_p : Piston diameter
 F_p : A pushing force
 F_0 : A separating force
 h_0 : Mean Fluid film thickness on valve plate
 h_{min} : Minimum Fluid film thickness on valve plate
 P_d : Discharge pressure in pump
 Q : Leakage flow rates on valve plate
 R_1, R_2 : Radius of inner seal land on valve plate
 R_3, R_4 : Radius of outer seal land on valve plate

Z : Number of pistons
 α : Tilting angle of cylinder block
 μ : Viscosity of working oil

1. Introduction

Despite the fact that the oil hydraulic axial piston pumps are more expensive than other types of pump, the use of the oil hydraulic axial piston pumps are rapidly increasing due to variable discharge characteristics, higher working pressures, higher volumetric and overall efficiencies. Oil hydraulic axial piston pumps have many tribological sliding parts. To get the best performance of oil hydraulic axial piston pumps, we have to find the optimal tribological solutions for relative motions between the sliding parts. The interface between the valve plate and the cylinder block is

* Corresponding Author,

E-mail : jungjy@moak.chonbuk.ac.kr

TEL : +82-63-270-2372; FAX : +82-63-270-3918

School of Mechanical and Aerospace System Engineering, Chonbuk National University, Chonbuk 561-756, Korea. (Manuscript Received July 24, 2002; Revised December 5, 2002)

the most important sliding part in axis-type axial piston pumps, because the cylinder block rapidly rotates on the fixed valve plate, and the pistons with an approximate half a revolution perform suction, and discharge of working oil through the kidney ports. Also, the pressure distribution on the valve plate varies momentarily, and force balance is needed to prevent the leakage and friction.

Many researches and studies have been carried out on the sliding components in oil hydraulic axial piston pumps. Various researches and studies on specialized design features to improve the action and the performance of oil hydraulic axial piston pumps have been described by Saitchenko (1950), Nation (1961) and Franco (1961), Shute and Turnbull (1963). In addition to these researches, an extensive survey of various inventions relating to these machines, some of which are concerned with certain valve plate design techniques, were conducted by McKewon and Milner (1966). Furthermore, extensive studies have been carried out on the principles of the balancing force between the valve plate and the cylinder block interface of the major tribological parts in oil hydraulic axial piston pumps (Hibbert, et al., 1971; Taylor, et al., 1984). However, the fluid film thickness on the valve plate in oil hydraulic axial piston pumps have not been revealed in detail, because of the difficulty involved in measuring the fluid film thickness. This difficulty results due to the very high rotational speed of the cylinder block on the valve plate and the continuous measurement of the fluid film thickness on the valve plate in real conditions is extremely difficult.

In the present study, the fluid film thickness between the valve plate and the cylinder block was measured by use of a gap sensor and a slip ring system under dynamic conditions in order to perform the tribological analysis and identify design the conditions in more detail.

2. Force Balance and Fluid Film Thickness on the Valve Plate

There are two principal axial forces acting on

the bearing surface between the valve plate and the cylinder block. One of these forces is a pushing force associated with highly pressurized pistons tending to push the cylinder block to the valve plate. The other force is a separating force associated with the pressure in the highly pressurized kidney port and across its lands tending to separate the cylinder block with the valve plate. If the pushing force due to the pistons under high pressure is too large, the faces will be subjected to high friction, rapid wear, overheating, and thereby reducing the mechanical efficiency. Alternatively, if the separating force due to the pressure distribution on the seal lands is too large, the cylinder block will be forced away from the valve plate leading to excessive leakage losses. It is essential to calculate these two forces as accurately as possible in order to maintain adequate balance between them. Most axial piston pumps have an odd number of pistons to reduce the pulsation of pressurized oil. Also, Since the number of cylinders containing the highly pressurized working oil is half of the total number of pistons, the pushing force can be calculated by the following equation :

$$F_p = \frac{\pi}{8} D_p^2 P_d Z \tag{1}$$

Also, the separating force can be calculated by :

$$F_0 = \frac{\pi}{4} P_d \left\{ \frac{R_4^2 - R_3^2}{\ln(R_4/R_3)} - \frac{R_2^2 - R_1^2}{\ln(R_2/R_1)} \right\} \tag{2}$$

The fluid film thickness on the valve plate is produced by a balance of these two forces. Considering the fluid film thickness between the adjacent faces of the valve plate and the cylinder block of the oil hydraulic piston pump (as shown in Fig. 1.) if the leakage flow rates is Q , the mean fluid film thickness (h_0) can be expressed in the following form :

$$h_0 = \left\{ \frac{12\mu Q}{\pi P_d} \cdot \frac{\ln(R_2/R_1) \cdot \ln(R_4/R_3)}{\ln(R_2/R_1) + \ln(R_4/R_3)} \right\}^{\frac{1}{3}} \tag{3}$$

As a result of the fluid film thickness in the discharge region being smaller than the fluid film thickness in the suction region, the cylinder block is tilted from the center of the valve plate. This

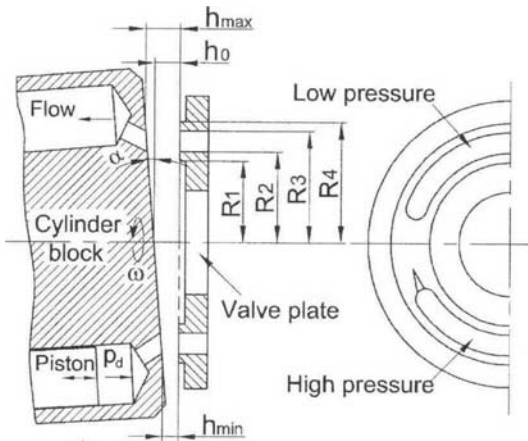

Fig. 1 Fluid film thickness between the valve plate and the cylinder block

causes an appearance of minimum fluid film thickness on the valve plate in the discharge region. Hence the minimum fluid film thickness (h_{min}) on the valve plate is given by :

$$h_{min} = \left\{ \frac{12\mu Q \cdot \ln(R_2/R_1) \cdot \ln(R_4/R_3)}{\pi P_d \cdot \ln(R_2/R_1) + (R_4/R_3)} \right\}^{\frac{1}{3}} - R_4 \sin \alpha \quad (4)$$

3. Experimental Apparatus and Test Method

The picture of the test cylinder block is shown in Fig. 2. The miniature gap sensor was mounted in the hole of the round cylinder to continuously measure the fluid film thickness during the working period of the test pump. A wire of the gap sensor was led through the center of the shaft in the cylinder block and taken out through the center of the valve plate and the rear housing. During the rotation of the cylinder block, signals from the gap sensor were transmitted to a recorder via a mercury-cell slip ring unit. A digital oscillographic recorder was used in order to display the gap sensor signals which were permanently stored in the recorder's memory and plotted by some other graphic means in a personal computer.

A section diagram of the test piston pump is shown in Fig. 3. The shape of the test valve plate is shown in Fig. 4. Also, a specification of the

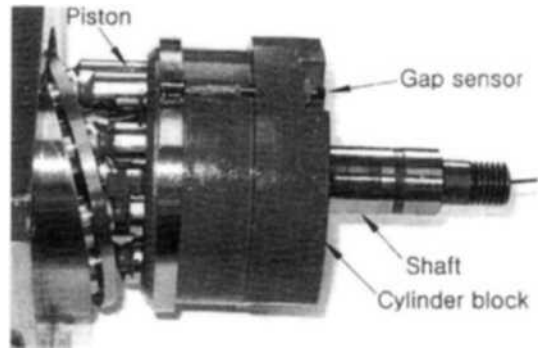

Fig. 2 Picture of test cylinder block

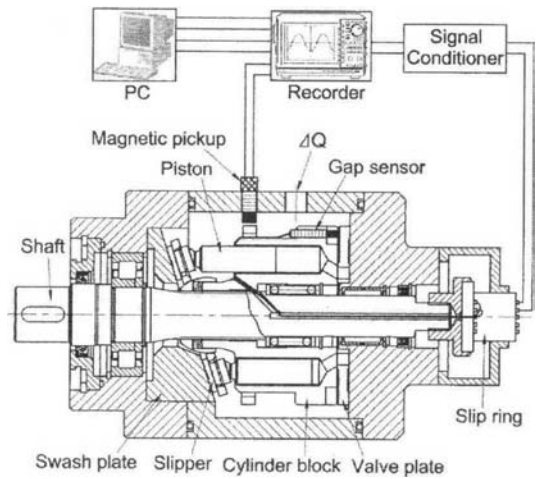

Fig. 3 Schematic diagram of test piston pump

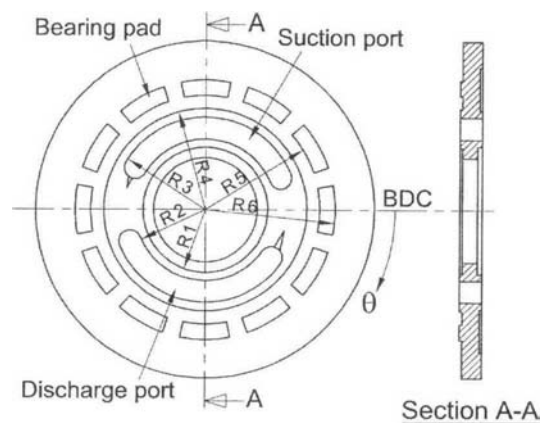

Fig. 4 Shapes of test valve plates

test valve plates is given in Table 1. Two valve plates were used in the tests. One of the valve plates was without a bearing pad while the other

Table 1 Specifications of test valve plates

	Valve plate without bearing pad	Valve plate with bearing pad
R_1 (mm)	24	24
R_2 (mm)	27.1	27.1
R_3 (mm)	35.6	35.6
R_4 (mm)	39	39
R_5 (mm)	—	44
R_6 (mm)	—	50

valve plate had a bearing pad. While rotating the drive shaft, the cylinder block slides on the valve plate having two kidney ports. Hence, two forces occur between the valve plate and the cylinder block. The fluid film thickness between the valve plate and the cylinder blocks is generated by the two balancing forces. The signal of the miniature gap sensor is continuously produced on the target valve plate while rotating the cylinder block.

The hydraulic circuit of the measurement system for these experiments is shown in Fig. 5. The test piston pump is driven by a variable speed electric motor (75 KW). The motor speed is continuously adjusted from 0 to 2,000 rpm by use of a vector inverter controller. The test piston pump is connected with the driving motor through an insulating coupling. The torque sensor is mounted in the middle of the test pump and the driving motor. The pressure, flow, and temperature sensors are mounted along the discharge line. The relief valve controls the discharge pressure from 0 to 35 MPa in the test pump. The heat exchanger was used to control oil temperature in test unit. Furthermore, a filter was mounted at the suction line and return line in order to maintain the cleanness of the working oil.

A broad range of experiments must be conducted to obtain reasonable data on the effect of fluid film thickness. In the experiments described in this paper, the three main variables which were considered are discharge pressure, rotational speed and valve plate geometry. The range of discharge pressure is 0–30 MPa and the range of rotational speed is 0–1800 rpm. The working oil is VG 46 and the oil temperature is controlled to within $40 \pm 2^\circ\text{C}$.

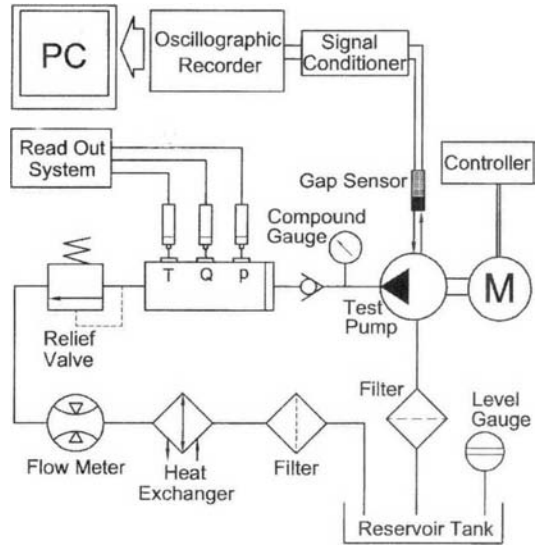
**Fig. 5** Hydraulic circuit of measurement system

4. Experimental Results

4.1 Variation of fluid film thickness with discharge pressure, rotational speed

Fig. 6 shows the variations of fluid film thickness on the valve plate without a bearing pad with discharge pressure at 1,500 rpm during the cylinder block rotation of one revolution. It was found that small pulsations of fluid film thickness during one revolution result from pressure pulsations produced by nine pistons in Fig. 6. Because the cylinder block is tilted from the center of the valve plate, the large changing pattern of the fluid film thickness shows opposite phenomena in both the discharge, and suction regions. The tilting of the cylinder block is caused by the clearance of spline and the clearance of bearing in the shaft. The angle of the tilting increases with increased discharge pressure.

At 10 MPa discharge pressure, the minimum fluid film thickness was measured to be $20 \mu\text{m}$ but at 30 MPa discharge pressure, the minimum fluid film thickness was measured to be $2 \mu\text{m}$ which is equivalent to 10 percent of $20 \mu\text{m}$. The direction of the cylinder block is from left to right (direction in Fig. 4) and the associated minimum fluid film thickness exists in the discharge region ($\theta = 100 \sim 135^\circ$). The location of minimum fluid film

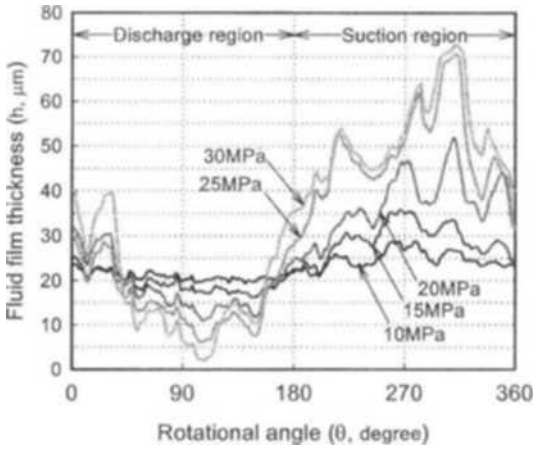

Fig. 6 Variations fluid film thickness on the valve plate without a bearing pad

thickness depends on the balancing forces between the valve plate and the cylinder block, and the eccentricity of the cylinder block. In the case of the valve plate without a bearing pad, the possibility of line contact between the valve plate and the cylinder block is remarkably increased under high pressure condition. Therefore, high friction and severe wear will appear and the friction loss will be increased.

The variations of fluid film thickness on the valve plate with a bearing pad, with discharge pressure at 1,500 rpm during the cylinder block rotation of one revolution is shown in Fig. 7. At 30 MPa discharge pressure, the minimum fluid film thickness was measured to be $9 \mu\text{m}$ which is a higher value (i.e. $7 \mu\text{m}$ more) than the value of the valve plate without a bearing pad. The difference of fluid film thickness between the discharge region and suction region is remarkably reduced compared with that of the valve plate without a bearing pad (see Fig. 6). Therefore, the shape of fluid film thickness shows a desirable pattern (in Fig. 7), and the tilting of the cylinder block is also decreased.

Fig. 8 shows a discharge pressure pulsation at 20 MPa, 1500 rpm. The general tendency of nine small pulsations was observed. These typical patterns are caused by the number of pistons in a piston pump. The range of pressure pulsation in the valve plate with a bearing pad is smaller than

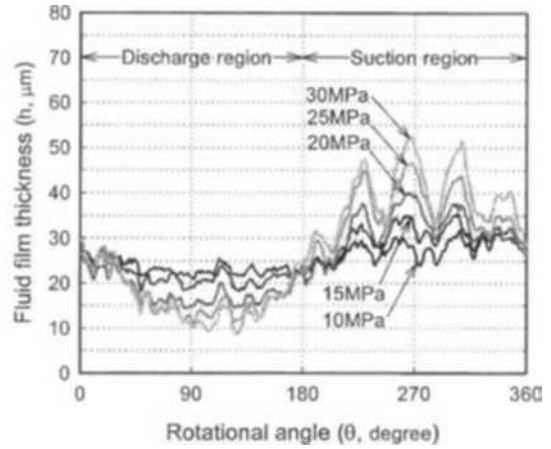

Fig. 7 Variations fluid film thickness on the valve plate with a bearing pad

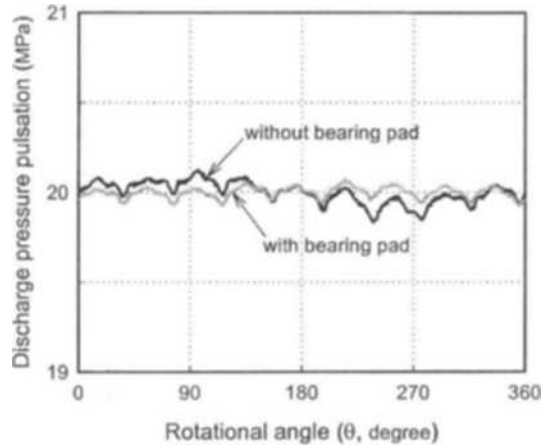

Fig. 8 Comparison of discharge pressure pulsation at 20 MPa

the valve plate without a bearing pad. It was found that the pressure pulsation is deeply related with the pattern of fluid film thickness on the valve plate.

Fig. 9 shows the variations of minimum fluid film thickness with rotational speed at a discharge pressure of 20 MPa. The fluid film thickness is affected by the rotational speed to a negligible degree. However, on the whole, the fluid film thickness is slightly increased as the rotational speed is increased. The minimum fluid film thickness of the valve plate with a bearing pad is larger than that of the valve plate without a bearing pad in all rotational speed ranges due

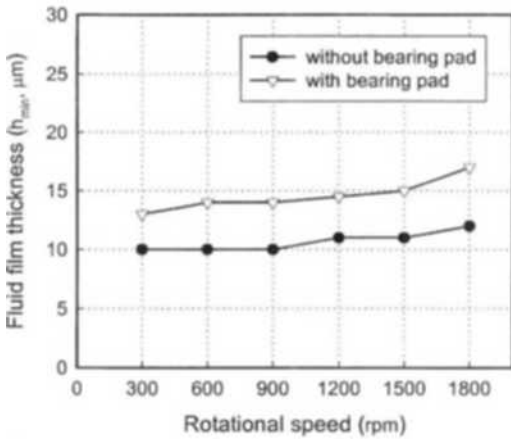

Fig. 9 Variations of minimum fluid film thickness with rotational speed at 20 MPa

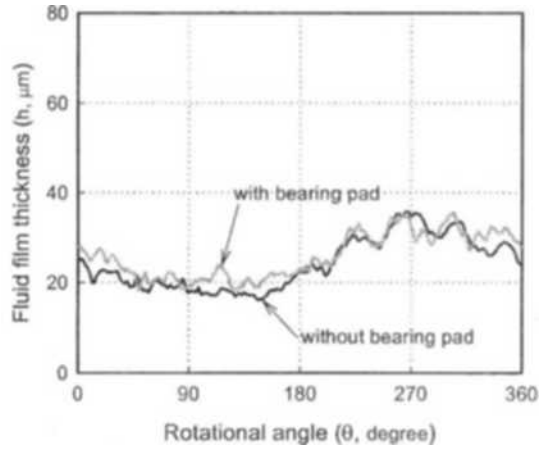

Fig. 10 Comparison of fluid film thickness at 15 MPa

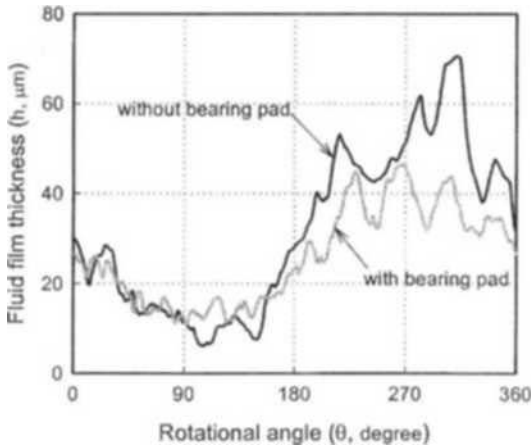

Fig. 11 Comparison of fluid film thickness at 25 MPa

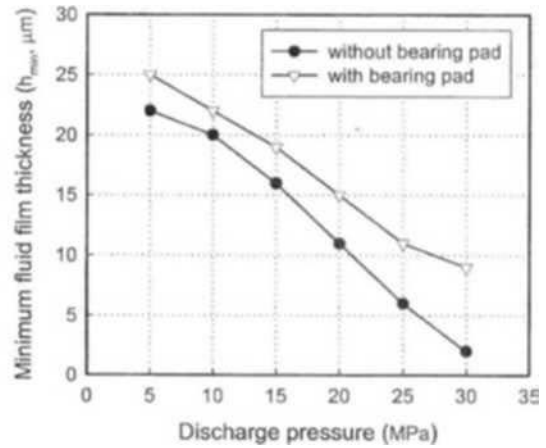

Fig. 12 Comparison of minimum fluid film thickness

to the effect of hydrodynamic lubrication over the bearing pad.

4.2 Comparison of fluid film thickness

The effects of bearing pad in valve plate are shown in Fig. 10 and Fig. 11. For low pressure below the range of 15 MPa, the pattern of fluid film thickness is almost similar. However, for high pressure above the range of 25 MPa, the pattern of fluid film thickness tends to be considerably different.

This difference occurs when the tilting of the cylinder block is combined with the high pressure condition. Also it was found that the tribological

action of the bearing pad on the valve plate can reduce the inclination of the cylinder block. In the case of the valve plate without a bearing pad, the inclination of the cylinder block drastically increases and the leakage flow rates increases significantly for high pressures above the range of 25 MPa. Therefore, the tilting of the cylinder block and leakage flow rates are affected by the bearing pad.

The effect of discharge pressure on the minimum fluid film thickness is shown in Fig. 12. The measured minimum fluid film thickness decreased linearly with respect to the discharge pressure. Especially, the minimum fluid film thickness of

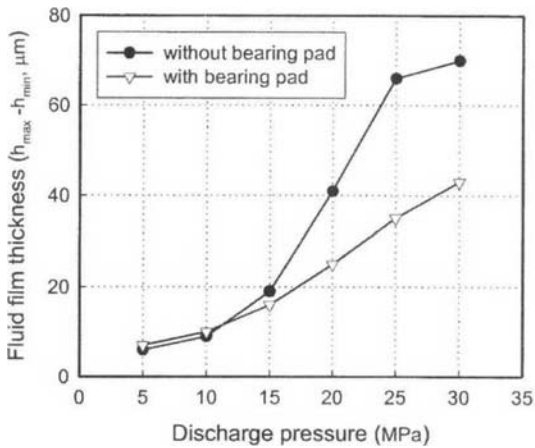

Fig. 13 Difference between maximum and minimum fluid film thickness

the valve plate without a bearing pad decreased more than that of the valve plate with bearing pad in high pressure range. Thus, for the high pressure range, the design of bearing pad on the valve plate could ensure larger fluid film thickness from $5 \mu\text{m}$ to $7 \mu\text{m}$ than the valve plate without a bearing pad.

Fig. 13 shows the difference between maximum and minimum fluid film thickness with discharge pressure. In the case of the valve plate without a bearing pad, the fluid film thickness abruptly increases with discharge pressure above 15 MPa. However, in the case of the valve plate with a bearing pad, the fluid film thickness increases almost linearly in all discharge pressure range. As mentioned earlier, this phenomenon is also related with the tilting of the cylinder block in the high pressure range.

4.3 Comparison of leakage flow rates and total efficiency

Fig. 14 shows the comparison of the leakage flow rates with respect to the discharge pressure at 1,500 rpm. The leakage flow rates increases as the discharge pressure increases. Especially for the valve plate without a bearing pad, the value of the leakage flow rate is low compared to the value of the valve plate with a bearing pad in the low pressure range. However, the leakage flow rate of the valve plate without bearing pad increases

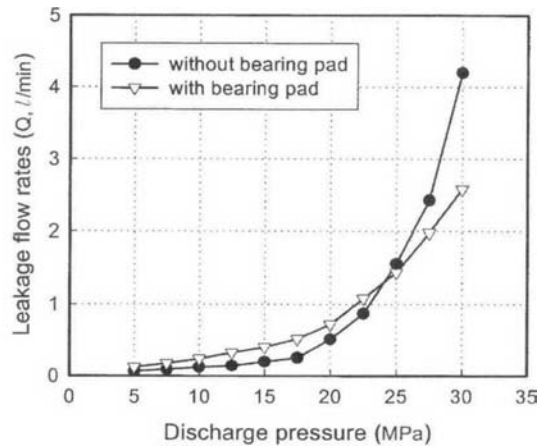

Fig. 14 Comparison of the leakage flow rates

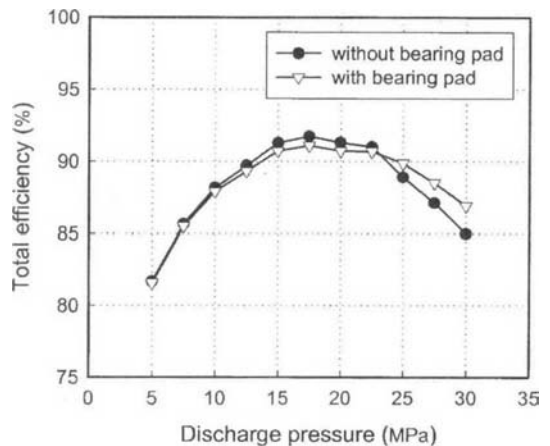

Fig. 15 Comparison of the total efficiency

sharply compared to that of the valve plate with a bearing pad in the high pressure range above 25 MPa due to the increase in fluid film thickness.

The comparison of the total efficiency with respect to the discharge pressure at 1,500 rpm is shown in Fig. 15. The maximum efficiency appeared in 15–20 MPa range. For low pressure range below 20 MPa, the efficiency value of the valve plate without a bearing pad is higher than that of the valve plate with a bearing pad due to the small fluid film thickness. However, for the high pressure range above 25 MPa, the efficiency of the valve plate with a bearing pad maintained a significant value compared with that of the valve plate without a bearing pad. This means that the bearing pad serves maintain a stable fluid

film thickness between the valve plate and the cylinder block.

In conclusion, the design of the bearing pad on the valve plate causes an increase in the fluid film thickness and leakage flow rates, and an efficiency decrease in the low pressure range. However the bearing pad could result in the stable changing of the fluid film thickness and maintain good efficiency in the high pressure range.

5. Conclusions

The fluid film thickness between the valve plate and the cylinder block was measured experimentally by use of a miniature gap sensor in real operating conditions. Two valve plates were used in the tests in order to investigate the effect of the bearing pad. One of the valve plates was without a bearing pad, while the other valve plate had a bearing pad and the following results were obtained :

(1) The minimum fluid film thickness on the valve plate exists in the discharge region ($\theta=100-135^\circ$) and the maximum fluid film thickness is located in the suction region due to the tilting of the cylinder block.

(2) The minimum fluid film thickness on the valve plate sharply decreases as the discharge pressure increases and the design of the bearing pad on the valve plate could ensure longer minimum fluid film thickness from $5\mu\text{m}$ to $7\mu\text{m}$ than the valve plate without a bearing pad.

(3) The discharge pressure pulsation is affected by the variation of the fluid film thickness.

(4) The fluid film thickness on the valve plate slightly increases as the rotational speed increases.

(5) The bearing pad on the valve plate could result in the stable changing of the fluid film thickness and maintain good efficiency in the high pressure range.

Acknowledgment

This work was supported by the Research Cen-

ter of Industrial Technology, Engineering Research Institute at CNU.

References

- Franco, N., 1961, "Pump Design by Force Balance," *Hydraulics & Pneumatics*, Vol. 14, No. 11, pp. 101~107.
- Hibbert, G., Lindsay, D. V., Shute, N. A. and Turnbull, D. E., 1971, "The Balancing of Piston and Valve Plate Forces in Axial-Piston Pumps and Motors," *BHRA*, Paper G2, pp. 13~40.
- Jung, J. Y., Oh, S. H. and Cho, I. S., 2001, "Lubrication Characteristics Between the Vane and the Rolling Piston in a Rotary Compressor Used for Refrigeration and Air-Conditioning Systems," *KSME International Journal*, Vol. 15, No. 5, pp. 562~568.
- Kim, H. C., Yoo, J. Y., Kang, H. S. and Kim, S. W., 1995, "Experimental Study on Flow and Mass Transfer in Rotor-Stator Disk Cavities," *KSME International Journal*, Vol. 9, No. 4, pp. 515~524.
- McKeown, J., Milner, D. A., Shute, N. A. and Turnbull, D. E., 1966, "Hydrodynamic Factors Affecting the Design of Valve Plates and Thrust Bearings," *Proc. I. Mech. E.*, Vol. 181, No. 1, pp. 653~665.
- Nation, H. J., 1961, "Some Experiments on Hydraulic Motor Distributor Valve Performance," *Jnl. Agricultural Engng.*, 6, 3, pp. 183~202.
- Saitchenko, J. S., 1950, "Force Balance Conditions of the Valve Plate and Rotor of an Axial Piston Pump," *Stanki. I. Instrument*, 10, pp. 28~29. *BHRA T 750*.
- Shute, N. A. and Turnbull, D. E., 1963, "Minimum Power Loss Conditions of the Pistons and Valve Plate in Axial-Type Pumps and Motors," *ASME*, Paper 63-WA-90, pp. 6~17.
- Taylor, R. and Lin, L., 1984, "The Application of Tribological Principles to the Design of the Valve Plate of an Axial Piston Pump-Part I," *The BFPR Journal*, Vol. 17. No. 2, pp. 257~262.